

23.3. NUCLEIC ACIDS

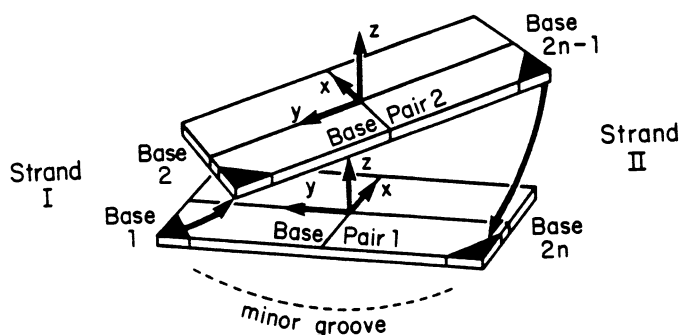

Fig. 23.3.2.10. Definitions of local reference axes ( $x, y, z$ ) at the first two base pairs of an  $n$ -base-pair double helix. Base 1 is paired with base  $2n$ , base 2 with base  $2n - 1$  etc. Shaded corners represent attachment points to sugar rings. Curved arrows denote 5'-to-3' 'positive' directions of each backbone chain. Note that when looking into the minor groove, as here, the two strands illustrate a clockwise rotation, upwards on the left and downwards on the right. This is true for A- and B-DNA, but for Z-DNA, the sense of the two backbone strands is reversed.

TRANSLATION

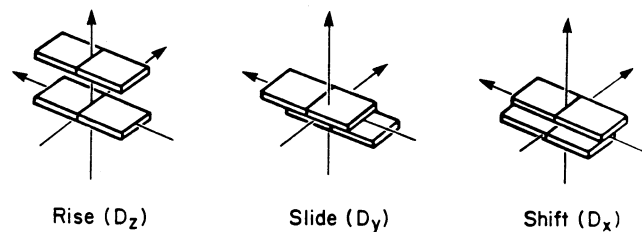
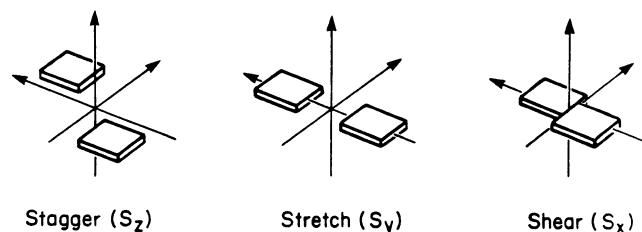
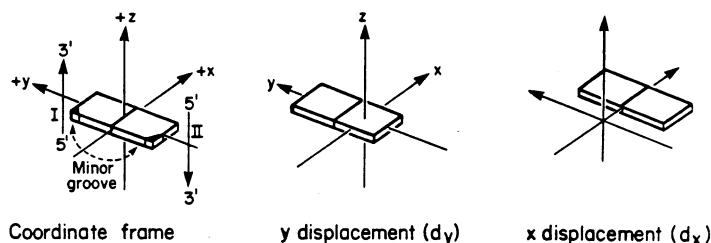

Fig. 23.3.2.12. Local helix parameters involving translations.  $y$  and  $x$  displacements describe shifts of a lone base pair along its long or short axis, respectively. Stagger, stretch and shear describe displacements of the two bases of a pair relative to one another. Rise, slide and shift describe displacements from one base pair to the next, via translations along the  $z, y$  and  $x$  axes, respectively.

ROTATION

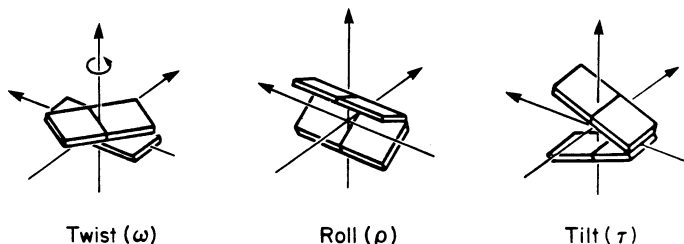
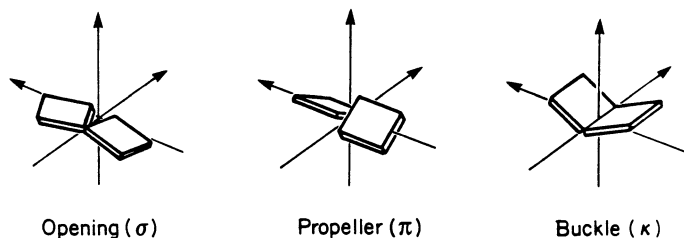
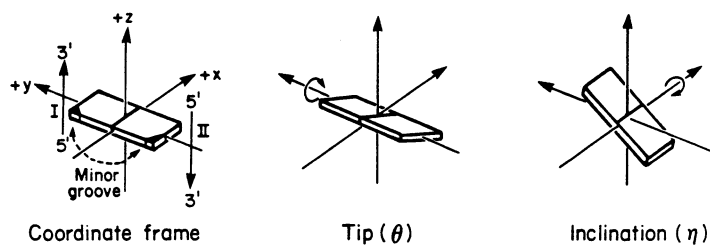

Fig. 23.3.2.11. Local helix parameters involving rotations. Tip and inclination describe the orientation of a base pair relative to the helix axis, produced by rotation about the base-pair long axis or short axis, respectively. Opening, propeller and buckle describe rotations of the two bases of a pair relative to one another. Twist, roll and tilt describe changes of orientation from one base pair to the next, via rotations about the  $z, y$  and  $x$  axes, respectively.

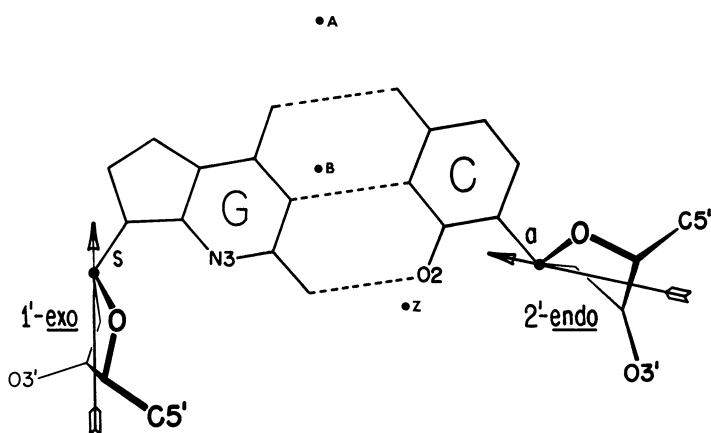

Fig. 23.3.2.13. *Syn* versus *anti* orientation about the glycosyl bond connecting sugar and base. Right: *anti* conformation, with  $\chi$  ca  $210^\circ$ . Left: *syn* conformation, with  $\chi$  around  $60^\circ$ . Both A- and B-DNA only employ the *anti* geometry; Z-DNA uses *anti* for pyrimidines and *syn* for purines, as shown here. Note that the 5'-to-3' direction in both rings is down into the paper. Hence, antiparallel backbone chains can be achieved only by a zigzag chain geometry with local chain reversals, as shown later in Fig. 23.3.3.4. Black dots labelled A, B and Z indicate the position of the helix axis relative to the base pairs in A-, B- and Z-DNA.